

**RATED
BEST IN QUALITY**
in an independent engineering study
UL Classified 60601-1
for medical equipment in a clinical setting*



OWNER'S MANUAL

EP-950™ Inversion Table

U.S. and foreign patents apply. Other foreign patents pending.

⚠ WARNING

It is your responsibility to familiarize yourself with the proper use of this equipment and the inherent risks of inversion, such as falling on your head or neck, pinching, entrapment, or equipment failure. FAILURE TO FOLLOW OWNER'S MANUAL INSTRUCTIONS AND WARNINGS COULD RESULT IN SERIOUS INJURY OR DEATH.

RESTRICTIONS ON USE

- **DO NOT** use the equipment without a licensed physician's approval. Carefully review the following list of medical contraindications for inversion with your licensed physician: (This is not an exhaustive list, it is intended only for reference)
 - Middle ear infection
 - Extreme obesity
 - Pregnancy
 - Hiatal hernia
 - Ventral hernia
 - Glaucoma
 - Retinal detachment
 - Conjunctivitis
 - High blood pressure
 - Hypertension
 - Heart or circulatory disorders
 - Spinal injury
 - Cerebral sclerosis
 - Acutely swollen joints
 - Recent stroke or transient ischemic attack
 - Bone weakness (osteoporosis)
 - Recent or unhealed fractures
 - Medullary pins
 - Surgically implanted orthopedic supports
 - Use of anticoagulants (including high doses of aspirin)
- **DO NOT** use if you are over 6'6" (198 cm) or over 300 lbs. (136 kg). Structural failure could occur or head/neck may impact the floor during inversion.
- **DO NOT** modify the equipment or use accessory attachments that are not recommended by the manufacturer. Utilize the equipment for its intended purpose only.
- This product is intended for home use only. **DO NOT** use in any commercial, rental or institutional setting.

PRECAUTIONS BEFORE USING

- **DO NOT** use the inversion table until you have thoroughly and carefully read the Owner's Manual, viewed the Instructional DVD, reviewed all other accompanying documents, and inspected the equipment. It is the responsibility of the owner to ensure that all users of the product are fully informed about the proper use of the equipment and all safety precautions.
- **NEVER** allow children to use the equipment unsupervised.
- **DO NOT** operate equipment while under the influence of drugs, alcohol, or medication that may cause drowsiness or disorientation.
- **ALWAYS** inspect the equipment prior to use. Make sure all fasteners are secure.
- **ALWAYS** replace defective components immediately and/or keep the equipment out of use until repair.
- **ALWAYS** position equipment on a level surface and away from water or ledges that could lead to accidental immersion or falls.
- **ALWAYS** wear securely tied lace-up shoes with a flat sole, such as a normal tennis style shoe. **DO NOT** wear any footwear that could interfere with securing the ankle clamps, such as shoes with thick soles, boots, high-tops or any shoe that extends above the anklebone.
- **ALWAYS** make sure the equipment is properly adjusted to the correct user settings prior to each use.
- Refer to additional warning notices posted on the equipment. If a product label or Owner's Manual should become lost, damaged or illegible, contact Customer Service.

PRECAUTIONS DURING USE

- **ALWAYS** keep bystanders and pets away from the inversion table during use.
- **DO NOT** use aggressive movements, or use weights, elastic bands or any other exercise or stretching device while on the inversion table.
- **ALWAYS** keep hands and fingers, clothing and hair away from moving parts to avoid injury.
- **DO NOT** drop or insert objects into any opening.
- New users, and users who are physically or mentally compromised, will require the assistance of a partner to ensure they are able to find the correct balance setting and can return to an upright position unassisted.
- If you feel pain or become light-headed or dizzy while inverting, immediately return to the upright position for recovery and eventual dismount.

*Medical Electrical Equipment, part I; General Requirements for Safety in accordance with Underwriters Laboratories, Inc.

USA: 1-800-847-0143, info@teeter-inversion.com

International: +1-242-362-1001, info@inversioninternational.com

DO NOT REMOVE

Specifications subject to change without notice.
©COPYRIGHT 2008; International law prohibits any copying. 12/08-0 EP-2020

ADJUSTING

BEFORE YOU INVERT make sure that the table rotates smoothly to the fully inverted position and back, and that all fasteners are secure. Make sure the user settings described below are properly adjusted for your unique needs and body type. Take your time finding your proper settings and remember them. Check these settings every time prior to using the equipment.

Roller Hinge: Find Your Setting

The Roller Hinge setting controls the responsiveness or rate of rotation. There are three holes; hole selection depends both on your body weight and the rotational responsiveness you desire (diagram at right). For users just learning to use the inversion table, we recommend starting with Setting C (Figure 1). **IMPORTANT:** Place the Roller Hinges in the same hole setting on each side.

	A Top – closest to roller Most Responsive Setting	B Middle Moderately Responsive	C Bottom – furthest from roller Least Responsive	
80 - 120 lbs.	● X			(36 - 54 kg.)
120 - 220 lbs.	X	●		(54 - 100 kg.)
220 - 300 lbs.	X	X	●	(100 - 136 kg.)

● Beginner / Partial Inversion
X Suggested for Full Inversion

Height Setting: Adjust the Main Shaft

The height settings are stamped on the Main Shaft in both inches and centimeters.

- Loosen the De-rattler knob.
- Pull out the height selector locking pin with your right hand while sliding the Main Shaft with your left (Figure 2).
- Slide the Main Shaft until the last setting you can read is one inch greater than your height. e.g. If you're 5'10" (178 cm) the last numbers you'll be able to read will be 5'11" (180 cm). **NOTE:** The best height setting for you will depend on your weight distribution and could vary one or two inches on either side of your actual height. Starting at one or two inches more than your height will help to ensure that the rotation of the table is not too fast.
- Release the height selector locking pin so that it fully engages in a hole. If you choose, re-tighten the De-rattler knob.

Tether Strap: Adjust to Desired Angle

For first time users, attach the Tether Strap to help control your angle of rotation (See Figure 3). You can increase the angle of rotation allowed by the Tether Strap as you become more comfortable using the table, or remove it all-together for full inversion.

Foot Platform: Find Your Setting

The Teeter Hang Ups Foot Platform can rotate into a High or Low setting (Figure 4). There is a one inch height difference between the settings. The setting you select will vary by the type of shoes you wear and your ankle type. Try inverting in both settings to determine which one is most comfortable for you.

The Foot Platform should be set so the ankle clamps are secure around the smallest part of the ankles (with minimal distance between the ankle clamp and the top of your foot), this will reduce sliding on the Table Bed while inverted.

Prepare to Mount

- **ALWAYS** wear securely tied, lace-up shoes with a flat sole, such as a tennis shoe.
- **DO NOT** wear shoes with thick soles, boots, high-tops or any shoe that extends above the anklebone, as this type of footwear could interfere with properly securing your ankles.

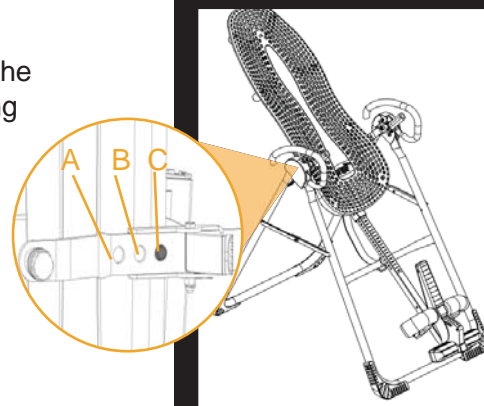

Fig. 1

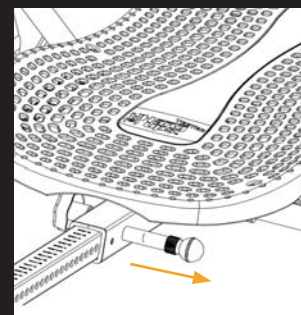

Fig. 2

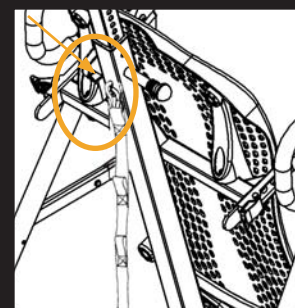

Fig. 3

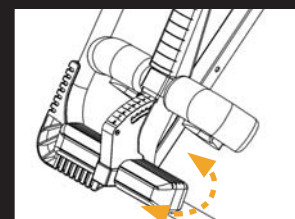

Fig. 4

Securing Your Ankles

- Stand with your back to the Table Bed - do not use the inversion table face-down.
- Step over the Main Shaft, placing your feet on the floor on either side. Press down and push out on the ratchet to open the ankle locking mechanism. To balance yourself, rest only your lower body against the Table Bed as you slide one ankle at a time between the ankle clamps onto the Foot Platform. Be sure to slide your ankle in from the side (Figure 5); DO NOT insert the foot through the ankle clamps as you would slide your foot into a shoe. Your feet should always be either on the floor or on the Foot Platform; never use any other part of the inversion table as a step (Figure 6 and 7).

⚠ WARNING

DO NOT step on the crossbar of the A-frame or on top of the ankle clamps as this could cause the table to rotate resulting in serious injury or death!

- Press your ankles back firmly against the rear ankle clamps.
- Rotate the top of the rear clamps slightly inward toward your ankles, this will increase your comfort while inverting.
- Push down on the handle of the Ankle Locking System, pull toward your legs and release when the fit is snug. Test the closure by jiggling the handle from front to back to make sure the foot clamps are locked securely (Figure 8). Make sure your pant legs do not interfere with obtaining a secure closure.
- Use the concept of **HEAR - FEEL - SEE** every time you secure your ankles: **HEAR** the locking ratchet click into place; **FEEL** the locking ratchet to make sure it is fully engaged in its setting; **SEE** that the ratchet is secure, and does not move out of position.

⚠ WARNING

DO NOT lean your upper body against the Table Bed before securing your ankles. **FAILURE** to engage the ankle locking system fully could result in serious injury or death! **DO NOT** deviate from these instructions.

Test Your Balance Setting

The inversion table is sensitively balanced, and it responds to very small changes in weight distribution. As a result, you must always test to make sure you have the correct height setting. Ensure that there is clearance to rotate in front, above and behind you. To begin, rest your head on the bed and place your arms at your sides, then slowly place your arms on your chest.

- If your head is lower than your feet, lengthen the height setting by one hole and test again.
- If your feet do not move at all, shorten the height setting by one hole and test again.
- If the table comes to rest with your feet lifted a few inches off the A-frame, then you have found the correct balance setting (Figure 9).

This is an important step - spend the time needed to find your correct balance setting. Your setting should remain the same as long as your weight does not fluctuate substantially.

⚠ WARNING

For your first few inversion sessions, ask a spotter to assist you until you are able to find your correct balance setting and are comfortable with the operation of the table.

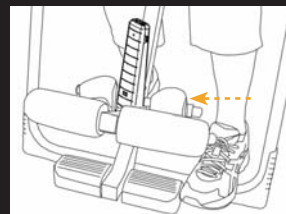

Fig. 5



Fig. 6



Fig. 7

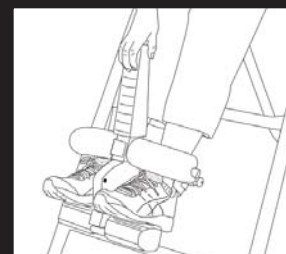

Fig. 8

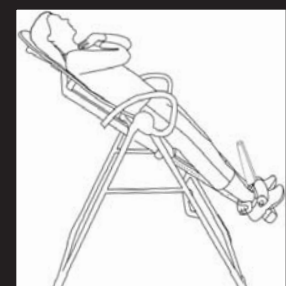

Fig. 9

INVERTING

Inverting

When correctly balanced, the table will rotate in response to simple arm movements. To invert, lift your arms overhead slowly and to return upright, bring your arms back to your sides. Your arms provide the weight needed to rotate the table. (Figure 10).

To ensure the inversion table does not rotate too far, too quickly:

- Set the Roller Hinges to Setting “C” (as explained on pg.2);
- Attach the Tether Strap to the underside of the table and test to maximum rotation;
- Raise one arm at a time, and do so very slowly (the faster you move, the faster the inversion table will rotate).

Returning Upright

To return to the upright position, put your arms at your sides. Since your body may have lengthened or shifted on the Table Bed during inversion, you may need to bend your knees to shift your body weight to the foot side of the pivot point. **DO NOT** lift your head or try to sit up (Figure 11).

Full Inversion

Definition: Hanging completely upside down by your ankles with your back free from the table. **DO NOT** attempt this step until you are comfortable with partial inversion.

⚠ WARNING

To reduce tipping hazard, confine all inverted activities to smooth movements. Aggressive exercises that involve vigorous body movement can cause the table to tip over, resulting in serious injury or death!

- Disconnect the Tether Strap.
- Set the Roller Hinges in the top hole setting “A” if you want the table to “lock” firmly while inverted. If you are 220 lbs (100 kg) or more, set the Roller Hinges in the “B” hole setting.
- From a balanced position on the table, slowly raise both hands over your head to begin rotation. You may need to assist the last few degrees of rotation by pushing on the floor or A-frame until the table pulls away from your back (Figure 12). In your correct balance setting, your weight will keep the table “locked” in this position until you are ready to return upright.

To Release from the Inverted “Locked” Position:

- Place one hand on the top of the Table Bed behind your head and place the other hand on the bottom bar of the A-frame in front of you.
- Pull both hands together (Figure 13). This will rotate the table out of the “locked” position. Slowly move your arms and elbows to your sides to complete the rotation.

USE CAUTION: Elbows protruding over the sides of the table bed could get pinched between the A-frame and the Table Bed as you return upright (Figure 14).

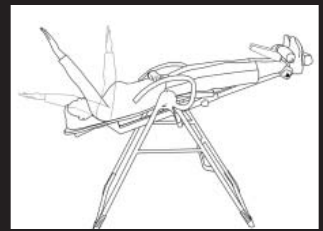

Fig. 10



Fig. 11

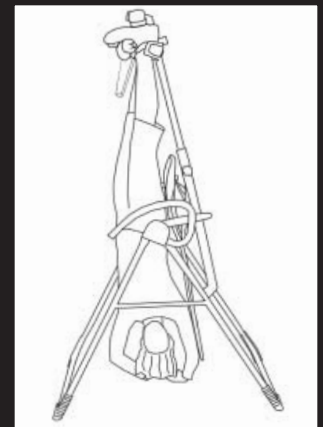

Fig. 12

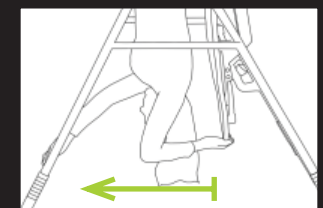

Fig. 13

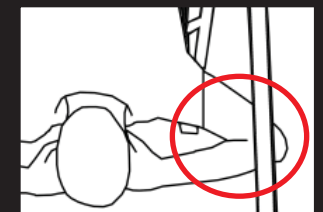

Fig. 14

⚠ WARNING

It is your responsibility to familiarize yourself with the proper use of the equipment and the inherent risks of inversion, such as falling on your head or neck, pinching, entrapment or equipment failure.

DO NOT use the inversion table until you have thoroughly and carefully read the Owner’s Manual, viewed the instructional DVD, reviewed all accompanying documents and inspected the equipment. **ALWAYS** test and inspect the equipment for smooth operation prior to each use.