

GL9500™ *Inversion Table*

U.S. and foreign patents apply. Other foreign patents pending.

Height / Weight Capacity:
Max 6'6" / 300 lbs. (198 cm, 136 kg)

⚠ WARNING

It is your responsibility to familiarize yourself with the proper use of the equipment and the inherent risks of inversion, such as falling on your head or neck, pinching, entrapment or equipment failure. FAILURE TO FOLLOW INSTRUCTIONS OR HEED WARNINGS COULD RESULT IN SERIOUS INJURY OR DEATH.

Restrictions on Use

- **DO NOT** use the equipment without a licensed physician's approval. Carefully review the following list of medical contraindications for inversion with your licensed physician: *(This is not an exhaustive list, it is intended only for reference)*
 - Middle ear infection
 - Extreme obesity
 - Pregnancy
 - Hiatal hernia
 - Ventral hernia
 - Glaucoma
 - Retinal detachment
 - Conjunctivitis
 - High blood pressure
 - Hypertension
 - Heart or circulatory disorders
 - Spinal injury
 - Cerebral sclerosis
 - Acutely swollen joints
 - Recent stroke or transient ischemic attack
 - Bone weakness (osteoporosis)
 - Recent or unhealed fractures
 - Medullary pins
 - Surgically implanted orthopedic supports
 - Use of anticoagulants (including high doses of aspirin)
- **DO NOT** use if you are over 6'6" (198 cm) or 300 lbs. (136 kg). Structural failure could occur or head/neck may impact the floor during inversion.
- **DO NOT** modify the equipment or use accessory attachments that are not recommended by the manufacturer. Utilize the equipment for its intended purpose only.
- This product is not intended for use in public facilities.

Precautions Before Using

- **DO NOT** use the inversion table until you have thoroughly and carefully read the Owner's Manual, viewed the Instructional DVD, reviewed all other accompanying documents, and inspected the equipment.
- **NEVER** allow children to use the equipment unsupervised.
- **DO NOT** operate equipment while under the influence of drugs, alcohol, or medication that may cause drowsiness or disorientation.
- **ALWAYS** inspect the equipment prior to use. Make sure that all fasteners are secure and that the equipment is located on a level surface.
- **ALWAYS** replace defective components immediately and/or keep the equipment out of use until repair.
- **ALWAYS** wear securely tied lace-up shoes with a flat sole, such as a normal tennis style shoe. **DO NOT** wear shoes with thick soles, boots, high-tops or any shoe that extends above the anklebone.
- **ALWAYS** make sure the equipment is properly adjusted to the correct user settings prior to each use.
- Refer to additional warning notices posted on the equipment.

Precautions during use

- **DO NOT** use aggressive movements, or use weights, elastic bands or any other exercise or stretching device while on the inversion table.
- **ALWAYS** keep hands and fingers away from moving parts to avoid injury. **DO NOT** drop or insert objects into any opening.
- First time users should use a spotter to ensure they are able to find the correct balance setting and are comfortable with the operation of the table.

PRIOR TO USE

Make sure that the table rotates smoothly to the fully inverted position and back, and that all fasteners are secure. Make sure the user settings described below are properly adjusted for your unique needs and body type. Take your time finding your proper settings and REMEMBER THEM. Check these settings every time prior to using the equipment.

1. Adjust the Roller Hinge:

The roller hinge setting controls the responsiveness or rate of rotation. There are three holes; hole selection depends both on your body weight and the rotational responsiveness you desire. For users just learning to use the inversion table, we recommend starting with Setting C. (See Figure 1) IMPORTANT: Place the roller hinges in the same hole setting on each side.

	A Top -- closest to roller Most Responsive Setting	B Middle Moderately Responsive	C Bottom -- furthest from roller Least Responsive	
80-120 lbs.	● X			(36-54 kg.)
120-220 lbs.	X	●		(54-100 kg.)
220-300 lbs.		X	●	(100-136 kg.)

● Beginner / Partial Inversion
X Suggested for Full Inversion

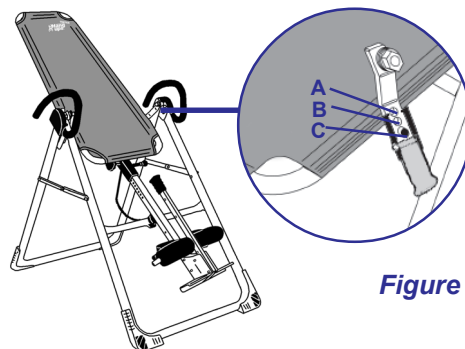

Figure 1

DO NOT REMOVE FROM TABLE

2. Adjust Height Setting:

The height settings are stamped on the main shaft in both inches and centimeters.

- Loosen the de-rattler knob.
- Pull out the height selector locking pin with your right hand while sliding the main shaft with your left. (See Figure 2)
- Slide the main shaft until the last setting you can read is 1" more than your height. e.g. If you're 5'10" (178 cm) the last numbers you'll be able to read will be 5'11" (180 cm).
NOTE: The best height setting for you will depend on your weight distribution and could vary one or two inches on either side of your actual height. Starting at one or two inches more than your height will help to ensure that the rotation of the table is not too fast.
- Release the height selector locking pin so that it fully engages in a hole. Retighten the de-rattler knob.

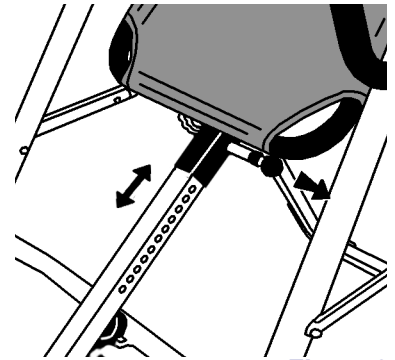

Figure 2

3. Attach Tether Strap:

For first time users, attach the tether strap to control your angle of rotation. (See Figure 3) You can increase the angle of rotation allowed by the tether strap as you become more comfortable using the table, or remove it all-together for full inversion.

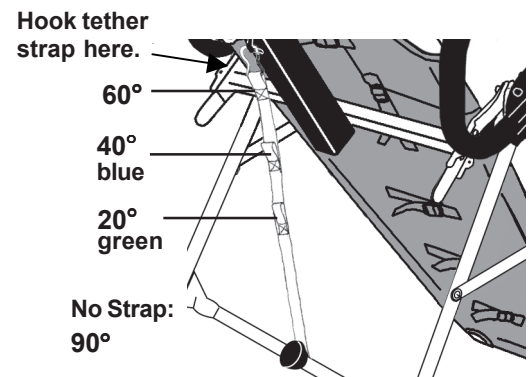

Figure 3

USING THE GRAVITY LOCK SYSTEM

1. Preparing to Mount:

- **ALWAYS** wear securely tied lace-up shoes with a flat sole, such as a normal tennis style shoe. **DO NOT** wear shoes with thick soles, boots, high-tops or any shoe that extends above the anklebone, as this type of footwear could interfere with properly securing your ankles.
- Push down on the knob of Gravity Lock Handle, close slightly, then push open-this allows the locking system inside the Gravity Lock Housing to disengage.

2. Mounting:

- Slide your ankles between the foam ankle clamps, resting your feet on the Foot Platform.
- Press your ankles back firmly against the rear ankle clamps.
- Rotate the top of the rear clamps slightly inward toward your ankles - this will increase your comfort while inverting.
- Pull the Gravity Lock Handle toward you. Make sure your pant legs do not interfere with obtaining a secure closure.
- Adjust the ratchet handle to make sure both the front and rear ankle clamps are snug against your ankles. (See Figure 4)

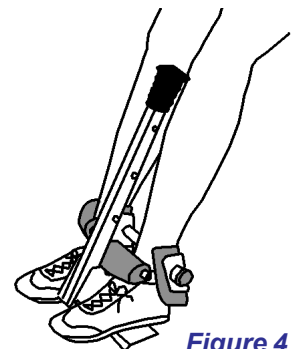

Figure 4

IMPORTANT!

Jiggle the Gravity Lock Handle from front to back to make sure the foot clamps are locked securely. **ALWAYS** carefully check to be certain the Gravity Lock Handle is locked securely each time you use your inversion table and make sure that both the front and rear ankle clamps are snug against your ankles or you could fall when the table inverts.

⚠ WARNING

Failure to lock the foot clamps fully could result in serious injury or death!
DO NOT deviate from these instructions.

3. Unlocking

- Push down the knob of the Gravity Lock Handle. (See Figure 5)
- Pull the Handle toward you slightly, allowing the spring locking system inside the Gravity Lock Housing to disengage. (See Figure 5A)
- Push out so that you have enough room to slide your feet out from between the Ankle Clamps .

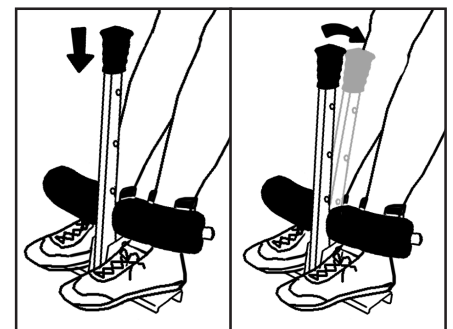

Figure 5

Figure 5A

⚠ WARNING

For your first few inversion sessions, ask a spotter to assist you until you are able to find your correct balance setting and are comfortable with the operation of the table.

BALANCING

The inversion table is like a sensitively balanced fulcrum. It responds to very small changes in weight distribution. As a result, you must always test to make sure you have the correct height setting. *Ensure that there is clearance to rotate without contacting other objects or people.*

- Rest your head on the nylon mat and place your arms at your side. Slowly place your arms on your chest.
 - ⇒ If your head is lower than your feet, lengthen the height setting by one hole and test again.
 - ⇒ If your feet do not move at all, then shorten the height setting by one hole and test again.
 - ⇒ If the table comes to rest with your feet lifted a few inches off the A-frame, you have found the correct balance setting! (See Figure 6)

The correct balance setting will allow your arm movements to rotate the table backward smoothly and slowly and to return to the full upright position. This is an important step, so you should spend as much time as you need to find your ideal height setting. Once you do find your setting, it should remain the same as long as your weight does not change substantially.

INVERTING

Review the insert "Important Details Regarding Inverting"

If correctly balanced, the inversion table will operate much like a teeter totter. By shifting weight to the head end of the table, you will move in that direction, and vice versa. Your arms will provide most of the weight needed to rotate the table. Fastening the tether strap before you start will prevent the table from inverting completely. (See Figure 7)

- Raise one arm slowly up and over your head, stopping along the way as required to control the downward rotation of the table. If you raise both arms, the speed and angle of inversion increases.
- When the table is at an angle you like, rest your arm on the table at whatever position it's in.

RETURNING UPRIGHT

- To return to the upright position, put your arms at your side. (See Figure 8)
Since your body may have lengthened, arm movements alone may not be sufficient to return you to the full upright position. You may need to bend your knees to shift your body weight to the foot side of the pivot point. *Do not lift your head or try to sit up.* (See Figure 8A)

FULL INVERSION

Definition: Hanging completely by your ankles with your back free from the table. *Do not attempt this step until you are comfortable with partial inversion.*

- Disconnect the tether strap.
- Set roller hinges in the top hole setting "A" if you want the table to "lock" firmly while inverted. If you are 220 lbs. (100 kg) or more, set the roller hinges in the "B" hole setting.
- From a balanced position on the table, slowly raise both hands over your head to begin rotation. You may need to assist the last few degrees of rotation by pushing on the floor or A-frame until the table pulls away from your back. In your correct balance setting, your weight will keep the table "locked" in this position until you are ready to return upright. (See Figure 9)

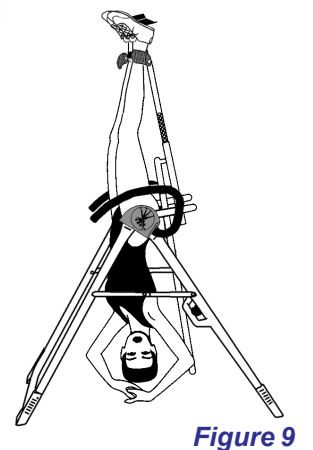
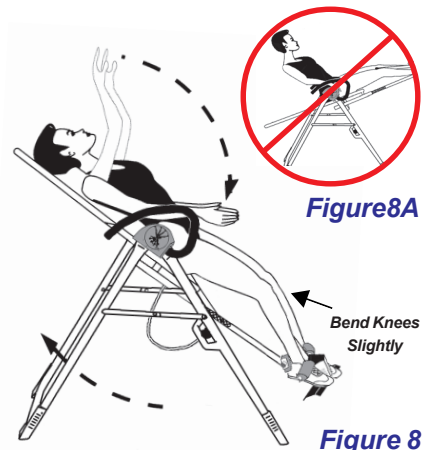
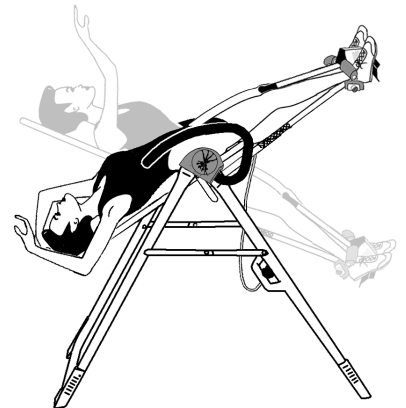
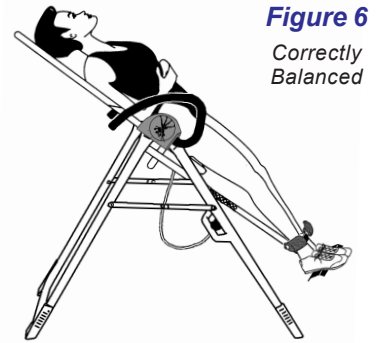

⚠ WARNING - Tipover Hazard

The equipment is structurally rated at a capacity of 6'6" (198 cm) or 300 lbs (136 kg). However, please confine all inverted activities to smooth movements. Aggressive exercises, which involve a lot of body movement, can cause the table to tip over resulting in serious injury or death!

To Release from the Inverted "Locked" Position:

- Place one hand over your shoulder and hold onto the corner of the table frame.
- Place your other hand on the bottom bar of the A-frame in front of you. (See Figure 10)
- Pull both hands together. This will rotate the table out of the "locked" position. Slowly move your arms and elbows to your sides to complete the rotation. Elbows protruding over the sides of the table bed could get pinched between the A-frame and the table bed as you return upright (See Figure 10A).
- If your body is stretched, you will need to bend your knees to shift body weight to the foot side of the pivot point. *Do not lift your head or sit up while releasing from the "locked" position.*

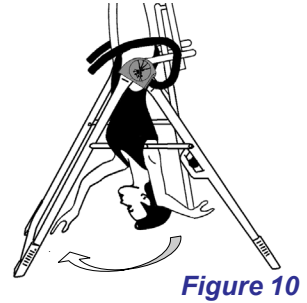

Figure 10

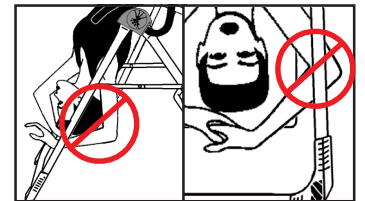
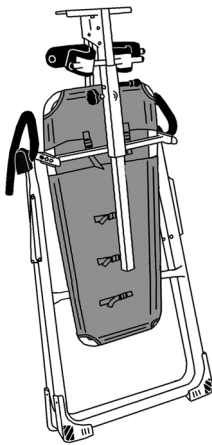

Figure 10A

Figure 11

Storage



STORING THE INVERSION TABLE

IMPORTANT NOTE: The GL9500™ will not fold for storage while in Setting "C" of the roller hinge. You must have the roller hinge set in either the "A" or "B" setting to do so.

- Loosen the de-rattler knob.
- Pull out the main shaft locking pin and slide the main shaft in all the way to the ankle clamp assembly. Allow the locking pin to engage in the storage setting.
- Rotate the table *opposite from use* until the table has turned 180 degrees and rests against the cross bar on the A-frame.
- Fold the legs of the A-frame base together for compact storage. (See Figure 11) Take care not to pinch your fingers.

⚠ WARNING

It is your responsibility to familiarize yourself with the proper use of the equipment and the inherent risks of inversion, such as falling on your head or neck, pinching, entrapment or equipment failure.

DO NOT use the inversion table until you have thoroughly and carefully read the Owner's Manual, viewed the Instructional Video, reviewed all other accompanying documents, and inspected the equipment. **ALWAYS** test and inspect the equipment for smooth operation prior to each use.



Classified as Medical Equipment, part 1 in accordance with UL 2601-1 and CAN/CSA C22.2; General Requirements for Safety in accordance with Underwriters Laboratories, Inc.

* any modification to this device will void the UL Classification



U.S. and foreign patents apply. Other foreign patents pending.
Teeter Hang Ups® is a registered trademark of STL International, Inc. and Inversion International, Ltd.
Specifications subject to change without notice.
© COPYRIGHT 2005, STL International, Inc. and Inversion International, Ltd. International Law Prohibits Any Copying. 0305-1

For information about the Teeter Hang Ups® 5-year warranty, or if you have any problems assembling the equipment or questions about its use, please contact Customer Service at the appropriate location below:

USA & Canada:

STL International, Inc.
9902 162nd St. Ct. E., Puyallup, WA 98375
Toll Free (Phone) 800-847-0143 (Fax) 800-847-0188
Local (Phone) 253-840-5252 (Fax) 253-840-5757
(email) Info26@STLIntl.com (web) www.STLIntl.com

International:

Inversion International, Ltd.
PO Box: AP 59245, New Providence Island, Bahamas
(Phone) +1-242-362-1001
(Fax) +1-242-362-1002
(email) Info@InversionInternational.com (web) www.InversionInternational.com

IMPORTANT DETAILS REGARDING INVERTING

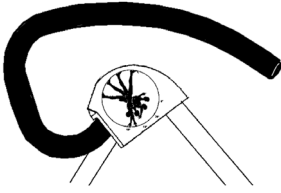

Begin Slowly:

- Invert only 15 - 20 degrees to begin with.
- Stay down as long as you are comfortable, even if only a few seconds at first.

Pay Attention to What Your Body Tells You:

- Remind yourself that your body is unique and it will tell you what is good for it.
- Come up slowly, dizziness after a session is a sign that you have come up too fast. **Important:** rest at horizontal for 30 seconds or more, allowing your body to readjust to being upright.
- Wait for a while after you've eaten before you invert.
- If inversion makes you nauseous, don't fight it. Come up as soon as you feel queasy, even if after only a few seconds. Give it time--it may take weeks or months before your inner ear gets used to inverting.

Make Changes Gradually:

- Increase the angle in small increments only if it is comfortable to you. You can gain all the benefits of inversion without ever inverting beyond 60 degrees. Muscle stretching and relaxation can be realized at as little as 20 degrees.
- You may want to increase your routine from 1-2 minutes to 5 or more over time - just listen to your body. Remember, this is not a no pain, no gain situation!

Moving While Inverted is Helpful:

- Add gentle stretching and light exercises only after you are comfortable with inversion. Movement while inverted may help make inversion a more comfortable experience and may help joints to realign and muscles to stretch and relax.
- Movement may be accomplished either by intermittent or rhythmic traction or by stretching and light exercise:

Intermittent traction consists of 1-2 minutes down and a half minute up, to be repeated as long as is comfortable at angles that are comfortable for you.

Rhythmic traction is a more evenly spaced rocking up and down.

Stretching can be done at partial inversion (torso rotation) or at full inversion (torso rotation, back extension and flexion).

Light exercise should only be performed from the fully inverted, "locked" position. Crunches, full-range sit-ups and squats provide a great way to strengthen muscles with virtually no loads to your joints.

Keep elbows close to the body while exercising to avoid impact with the A-frame. DO NOT use weights, elastic bands or any other exercise or stretching device while on the inversion table. Confine all inverted activities to smooth movements. Aggressive exercises, which involve a lot of body movement, can cause equipment to tip over resulting in serious injury or death.

Do It Regularly:

- Make inversion a regular routine and integral part of your life...that is how you will experience the most benefits!

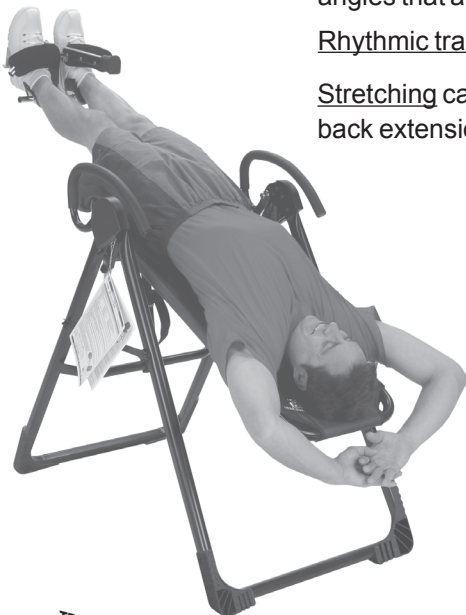

INVERSION: YOUR WAY TO A *BETTER BACK, BETTER BODY.*

Inversion puts gravity to work for you by placing your body in line with the downward force of gravity. Not only can inversion therapy help to temporarily relieve back pain, but it also can be used as a method to relieve other negative effects that gravity has on your body. Inversion can also be used as a proactive approach to help maintain overall back health. Hanging upside down can help to stretch and relax muscles, reduce stress, and provide healthy movement for ligaments.

- Inversion temporarily elongates the spine, increasing the space between the vertebrae, which relieves the pressure on discs, ligaments and nerve roots. Less pressure means less back pain.
- Lying down in bed only releases 75% of standing body weight on the spinal discs. The hundreds of ligaments and muscles that encase and stabilize the spine act like a bunch of rubber bands holding the spine in compression equal to 25% of standing body weight. Inverting to 60° helps to reduce the disc pressure to at or near zero.¹
- The inner core of your discs is made of jellylike material which provides the “cushioning” in your back. You can lose up to .5” - .75” (1.3-2.0 cm) in height daily during your waking hours from the compressive effects of gravity. This daily height loss reverses overnight, but not 100%, resulting in permanent height loss, loss of flexibility and shock absorption. While inverted, you are able to temporarily reverse the downward pressure on your discs, helping the discs to recover and regain lost moisture and lost height, with improved flexibility.
- Inverting yourself to as little as 20-25° for even a few minutes can help relax tense muscles and speed the flow of lymphatic fluids which flush out the body’s wastes and carry them to the blood stream.
- Unlike the cardiovascular system, the lymphatic system has no pump. Only the alternate contraction and relaxation of muscles moves lymphatic fluid “uphill” through capillaries and one-way valves to the upper chest for cleansing. Inverting the body so that gravity works with, not against, these one-way valves stimulates the flow of the lymph system, helping to clear toxins from the body.
- Your heart must work against gravity to pump blood up to your brain, which is the body’s largest consumer of oxygen. Inversion is a simple way to improve circulation to the upper body.
- When inverting, you are helping your heart to clear the blood from your feet, legs, and lower body. This allows the blood in your limbs to circulate more easily, which may help to drain blood from varicose veins.

The constant pull of gravity has a cumulative negative effect on the joints and spinal discs. Used sensibly, inversion is extremely beneficial, and no more dangerous than many other popular and widely-practiced fitness activities. Sometimes there’s an explanation for why inversion works and sometimes there isn’t.

The experience of thousands of people who invert regularly is that it gives them the relief from back pain they’ve been looking for. Just as important, they gain the rejuvenating effects of inversion on the entire body, providing health benefits far beyond the relief of back pain.

¹ Nachemson, A and Elfstrom, G; Intravital Dynamic Pressure Measurements in Lumbar Discs. *Scandinavian Journal of Rehab Medicine*, supplement, 1970)

